

LED LAMP SPECIFICATIONS:	10W	20W	30W	50W
Luminaire lumens (with diffuser)	800 lm	1600 lm	2400 lm	4000 lm
Lumens from chip (no diffuser)	900 lm	1800 lm	2700 lm	4500 lm
Useful lumens	740 lm	1480 lm	2230 lm	3720 lm
Rated Wattage	10W	20W	30W	50W
Rated luminous flux	740 lm	1480 lm	2230 lm	3720 lm
Nominal life time of the lamp	25,000 hrs	25,000 hrs	25,000 hrs	25,000 hrs
Colour temperature	4000K	4000K	4000K	4000K
Number of switching cycles before premature lamp failure	12500	12500	12500	12500
Warm-up time up to 60% of the full light output	Instant full light	Instant full light	Instant full light	Instant full light
Dimmable	No	No	No	No
Nominal beam angle	120°	120°	120°	120°
Rated power	10W	20W	30W	50W
Rated lamp lifetime	25,000 hrs	25,000 hrs	25,000 hrs	25,000 hrs
Lamp power factor	>0.9	>0.9	>0.9	>0.9
Lumen maintenance factor at end of nominal life	70%	70%	70%	70%
Starting time	<0.5s	<0.5s	<0.5s	<0.5s
Colour rendering	≥80	≥80	≥80	≥80
Colour consistency	Within a six step Macadam ellipse	Within a six step Macadam ellipse	Within a six step Macadam ellipse	Within a six step Macadam ellipse
Rated peak intensity	255cd	509cd	764cd	1273cd
Rated beam angle	120°	120°	120°	120°
Voltage / Frequency	240V~50Hz	240V~50Hz	240V~50Hz	240V~50Hz

Not suitable for accent lighting

INSTALLATION INSTRUCTIONS

A guide for qualified electricians



Pack Contents:
1 x LED floodlight complete with mounting bracket

Model:

**FLD10PIRBK / FLD20PIRBK / FLD30PIRBK / FLD50PIRBK
FLD10PIRWH / FLD20PIRWH / FLD30PIRWH / FLD50PIRWH**

120° PIR LED Floodlights With Mounting Bracket

These instructions are provided as a guideline to assist you.

**PLEASE READ THESE INSTRUCTIONS BEFORE INSTALLATION
AND RETAIN FOR FUTURE REFERENCE**

Eterna FLDPIR RANGE

This luminaire contains built-in LED lamps.



LED

The lamps cannot be changed in the luminaire.

874/2012



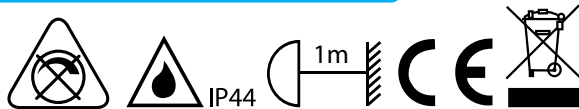

Email: sales@eterna-lighting.co.uk / technical@eterna-lighting.co.uk

INTRODUCTION:

The floodlight incorporates a PIR (Passive Infra Red) sensing device which continuously scans a preset operating zone and immediately switches the light on when it detects movement in that area.

This means that whenever movement is detected within the range of the sensor the light will switch on automatically to illuminate the area you have selected to light. While there is movement within range of the unit the light will remain on.

READ THIS FIRST:

Check the pack and make sure you have all of the parts listed on the front of this booklet. If not, contact the outlet where you bought this product.

This product must be installed by a competent person in accordance with the current building and IEE wiring regulations.

As the buyer, installer and/or user of this product it is your own responsibility to ensure that this fitting is fit for the purpose for which you have intended it. Eterna Lighting cannot accept any liability for loss, damage or premature failure resulting from inappropriate use.

This product is designed and constructed according to the principles of the appropriate British Standard.

Switch off the mains before commencing installation and remove the appropriate circuit fuse or lock off MCB.

This unit is suitable for outdoor use.

This product is designed for permanent connection to fixed wiring: this must be a suitable circuit (protected with the appropriate MCB or fuse).

Before making fixing hole(s), check that there are no obstructions hidden beneath the mounting surface such as pipes or cables.

Make sure that the fixings are strong enough to support the considerable weight of the fitting and hold it rigidly.

The lamp must be positioned so that there is at least 1M between the luminaire and any illuminated surface.

When making connections ensure that the terminals are tightened securely and that no strands of wire protrude. Check that the terminals are tightened onto the bared conductors and not onto any insulation.

This product must be connected to Earth termination.

This product is not intended to be used by children and persons with sensory, physical and/or mental impairments that would prevent them from using it safely.

You are advised at every stage of your installation to double-check any electrical connections you have made. After you have completed your installation

there are electrical tests that should be carried out, these tests are specified in the current IEE wiring and building regulations.

SPECIFICATIONS:

- 10W-30W detection range: max. 9m at approx. 120° scan.
- 50W detection range: 4-8m (adjustable) at approx. 120° scan.
- Duration time adjustment: (10±3) seconds to (10±3) minutes.
- Lux adjustment: 5-2000lux.

WHERE TO FIT YOUR PIR FLOODLIGHT:

To achieve best results we suggest you take the following points into consideration:

Do not mount on a surface that has vibration.

Ideally the PIR floodlight should be mounted 2.5 metres to 3 metres above the area to be scanned (refer to fig.1 (10-30W) and fig.2 (50W) opposite).

To avoid damage to the unit do not aim sensor towards sun.

Avoid positioning the sensor unit adjacent to a bright light source which may prevent the unit from operating when the lux control is set to operate in dark conditions.

Avoid nuisance / false triggering by directing sensor away from:

- Trees and shrubs
- Reflective surfaces such as smooth white walls
- Swimming pools
- Heat sources such as boiler flues

The PIR sensor scanning specifications (approximately 8 metres at 120°) may vary slightly depending on the mounting height and location.

The detection range of the unit may also alter with temperature change. Before selecting a place to install your PIR floodlight you should note that movement across the scan area is more effective than movement directly towards or away from the sensor. (Refer to fig.3 opposite).

If movement is made walking directly towards or away from the sensor and not across the sensor the apparent detection range will be substantially reduced (refer to fig. 4 opposite).

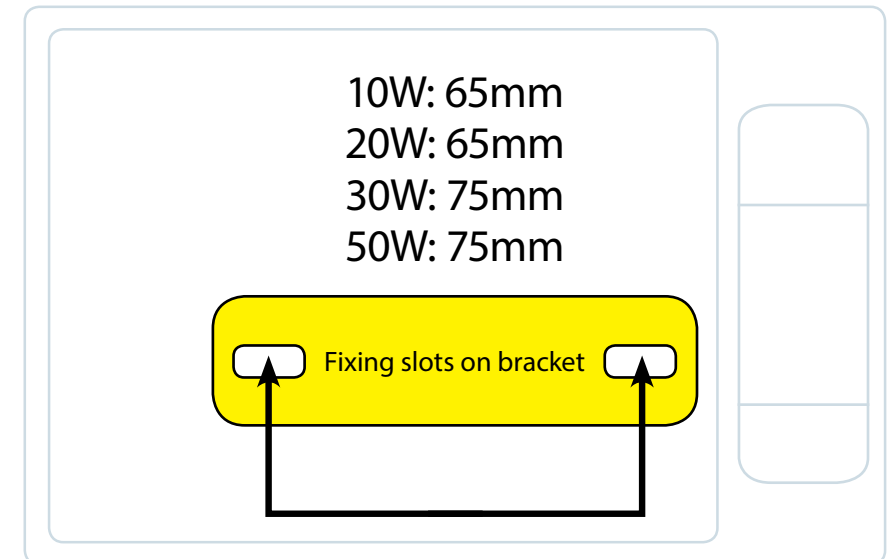
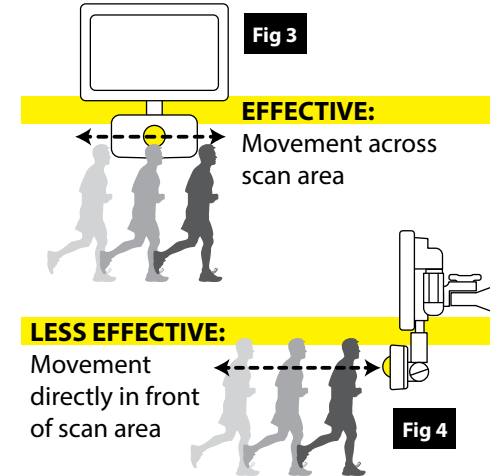
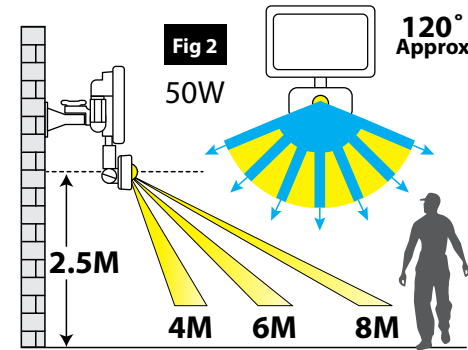
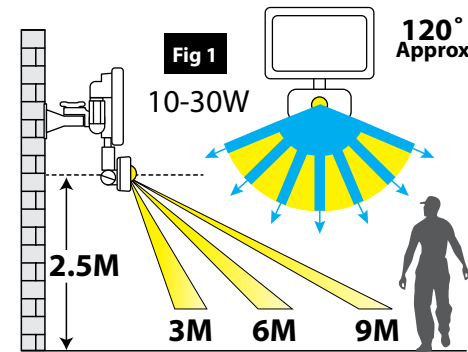

INSTALLATION:

- 01) Switch off the mains before commencing installation.
- 02) Using the bracket as a template mark and then drill the appropriate fixing holes.
- 03) Secure the bracket with suitable fixings.
- 04) Unscrew connector on back of fitting and make the electrical connections:
 - Live - Brown / Red
 - Neutral - Blue / Black
 - Earth - Yellow / Green
- 05) Ensure the connector is secured tightly to maintain IP rating.
- 06) Adjust the direction of the floodlight and tighten the fixings on the back of the fitting.
- 07) Restore mains power.
- 08) Adjust the PIR sensor to the desired settings.

Fig 5: 10-30W PIR Controls

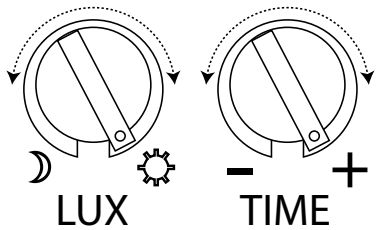
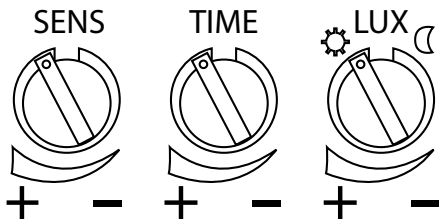

Fig 6: 50W PIR Controls



UNDERSTANDING THE CONTROLS:

(Please refer to Fig. 5 / 6 below)

ADJUSTING THE DURATION TIME:

The length of time the unit remains switched on after activation can be adjusted from (10±3) seconds to (10±3) minutes approximately. Rotating the TIME screw from (+) to (-) will reduce the duration time.

Note: Once the light has been triggered by the PIR sensor any subsequent detection will start the timed period again from the beginning.

ADJUSTING THE LUX CONTROL LEVEL:

The Lux control module has a built-in sensing device (photocell) that detects daylight and darkness. The (☼) position denotes that the floodlights can work at day and night, and the (☾) position only work at night. You can set to operate the unit at the desired level by adjusting the LUX screw.

SETTING THE CONTROLS - WALK TEST:

Turn the Lux control screw to light (☼) & ensure that the TIME control screw is set at the minimum duration time (-) position. The floodlight will now switch on and remain on for about 10 seconds after each detection.

- 01) Adjust time control to required setting.
- 02) To set the light level at which the floodlight will automatically switch "on" at night, turn the LUX control screw from daylight (☼) to night (☾). If the floodlight is required to switch on earlier, e.g. dusk, wait for the desired light level, then slowly turn the LUX control screw towards daylight while someone walks across the center of the area to be detected. When the floodlight switches on stop adjusting. You may need to make further adjustments to achieve your ideal light level setting.

(50W VERSION ONLY) ADJUSTING THE SENSITIVITY:

The sensitivity means the maximum distance which PIR sensor can be triggered by movement - turning the SENS knob from (+) to (-) will decrease the sensitivity.

CLEANING:

- To avoid dust build-up and ensure proper functioning of the floodlight, please wipe the sensor lens lightly with a damp cloth every 3 months.
- Disconnect the power and clean the exterior only of this fitting with a moist (not wet) cloth.
- Do not use any chemical or abrasive cleaners.

TROUBLESHOOTING AND USER HINTS:

Note: all passive infra red detectors are more sensitive in cold and dry weather than warm and wet weather.

PROBLEM	POSSIBLE CAUSE	SUGGESTED REMEDY
Light does not switch on when there is movement in the detection area.	1. No mains voltage	Check all connections, and MCB Fuses / switches
	2. Nearby lighting is too bright	Relocate the unit
	3. Controls set incorrectly	Adjust Lux setting
	4. Wired incorrectly	Check wiring and confirm its wired as per the wiring instructions opposite
	5. Sensor positioned in wrong direction	Relocate the unit
Light switches on for no apparent reason (false trigger)	1. Heat sources such as air-con, vents, heaters, flues, other outside lighting, moving cars trees or shrubs are activating sensor	Relocate the unit
	2. Interference from on/off switching of electric fans or lights on the same circuit as your security floodlight. (This problem does not always occur but a faulty switch or noisy fluorescent light may cause the security floodlight to switch on)	Should the false triggering become, troublesome, consider: (a) Replacing a faulty switch (b) Replacing noisy fluorescent tubes and/or starters (c) Connecting the floodlight to a separate circuit (in most cases where one or more of the above suggestions have been carried out, false triggering has been reduced)
	3. Reflection from swimming pool, or reflective surface such as smooth white walls	Relocate the unit
Light remains on	Time is set too long	Reduce time
Light remains on at nighttime	Possible heat source in detection zone	Cover PIR sensor lens with a thick cloth, if the light turns off check detection area for heat or reflective source, reposition head and decrease the sensitivity setting if this control is available
Light switches on during daylight hours	LUX control screw is set to daylight position	Turn the LUX control screw to desired light level setting
When setting the lux controls in daylight the detection distance becomes shorter	Interference by sunlight	Re-test at night

EVENTUALLY, YOU MAY WANT TO REPLACE THIS PRODUCT:

Regulations require the recycling of Waste from Electrical and Electronic Equipment (European "WEEE Directive" effective August 2005—UK WEEE Regulations effective 2nd January 2007). Environment Agency Registered Producer: WEE/GA0248QZ.

WHEN YOUR PRODUCT COMES TO THE END OF ITS LIFE OR YOU CHOOSE TO REPLACE IT, PLEASE RECYCLE IT WHERE FACILITIES EXIST - DO NOT DISPOSE WITH HOUSEHOLD WASTE.

IF YOU EXPERIENCE PROBLEMS:

If you believe your product is defective, please return it to the place where you bought it. Our Technical Team will gladly advise on any Eterna Lighting product, but may not be able to give specific instructions regarding individual installations.

LAMP REPLACEMENT:

The light source contained in this luminaire shall only be replaced by the manufacturer, service agent or a similar qualified person.

CAUTION, RISK OF ELECTRIC SHOCK.

