

### Safety Information

> All electrical work must be undertaken by a qualified contractor to ensure compliance with latest edition BS 7671 and IEE/IET wiring regulations.

> Before installing a Trinity LED Linear or doing any maintenance, ensure power supply is turned off at the circuit breaker or fuse box.

> This product is designed for permanent connection to fixed wiring; the circuit should be protected with the appropriate MCB of fuse.

### Environment

> Please Do NOT dispose of electrical items or packaging as unsorted waste, use the recycling facilities provided by your local authorities.

### PRODUCT DIMENSIONS

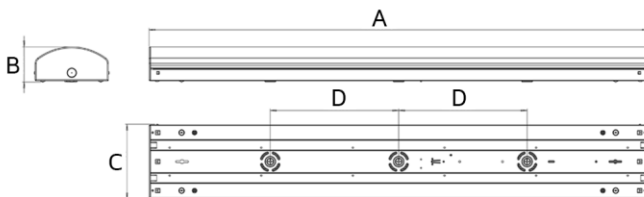

A	B	C	D
1165	79	170	300
1500	79	170	300
1800	79	170	300

All units in mm

### Important Warranty Information

The Trinity LED Linear has a 3 year warranty, which can be extended free of charge to 5 years by registering online via the website address below. The registrant must provide the product part number and date of manufacture, which can be found on the label attached to the luminaire housing.



Certificate No. FS 590684



Certificate No. EMS 590685

NET LED Lighting  
Buckingway Business Park  
300 Anderson Road  
Cambridge  
CB24 4UQ  
sales@netled.co.uk  
www.netled.co.uk

Technical Helpline: 01223 851505  
Email: support@netled.co.uk

www.netled.co.uk/downloads

Distributed by



### TRINITY LINEAR INSTALLATION GUIDE

Part Number	Description
NET-41-11-30	4ft Standard 23W/32W
NET-41-11-32	4ft Emergency 23W/32W
NET-41-11-34	4ft Dimmable 32W
NET-41-11-36	4ft Dim Emg 32W
NET-41-11-40	5ft Standard 34W/50W
NET-41-11-42	5ft Emergency 34W/50W
NET-41-11-44	5ft Dimmable 50W
NET-41-11-46	5ft Dim Emg 50W
NET-41-11-50	6ft Standard 41W/60W
NET-41-11-52	6ft Emergency 41W/60W
NET-41-11-54	6ft Dimmable 60W
NET-41-11-56	6ft Dim Emg 60W

### SUPPLY/EARTH CLASS

220-240V AC 50/60 Hz

Fig.1 Mains Input Termination



Class I

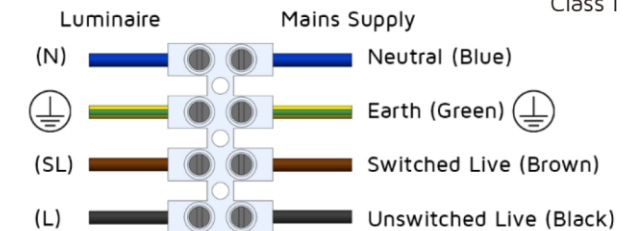

**Installation procedure:** Carefully read the installation instructions and ensure the mains supply is isolated before installation. Please follow the safety information overleaf before carrying out any installation. Please retain this leaflet for future reference.



Replaceable (LED only) light source by a professional

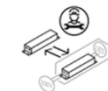

Replaceable control gear by professional

**Step 1:** Carefully remove the Linear from the packaging. Press the diffuser (close to the end cap) to release it from the metal housing.

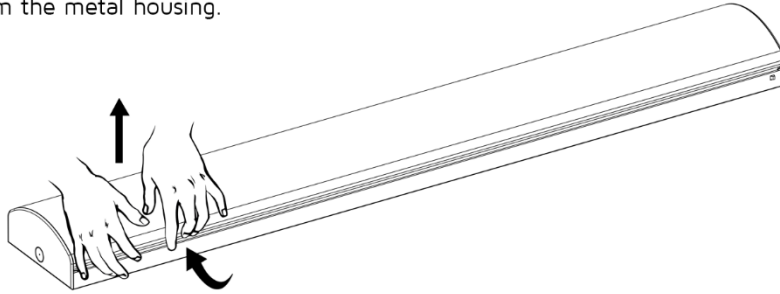

**Step 2:** Select a cable entry point that best suits the application. For side cable entry, drill out the 20mm cable gland position, then secure the cable with a Cable Gland. For rear cable entry, select one of the three pre-cut cable access holes.

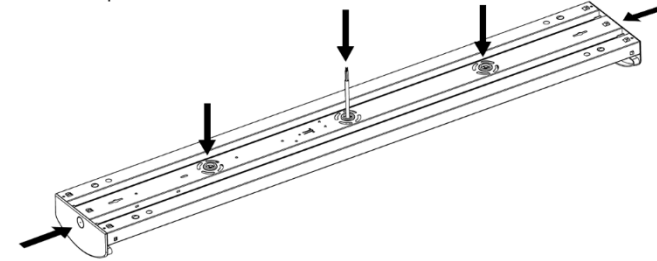

**Step 3:** Attach the Linear to the ceiling by means of the surface mount holes on the Metal Housing and the included fixing screws. A suspension kit is available if required.

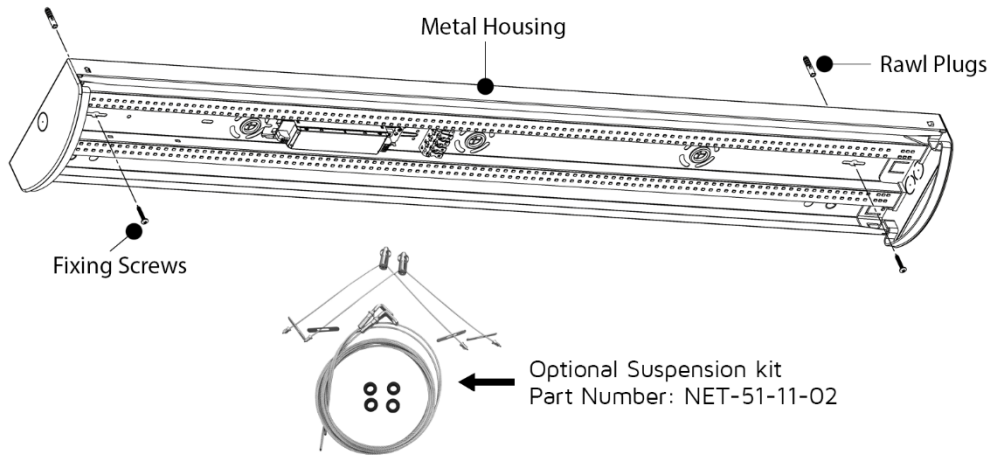

**Step 4:** Connect the input wires according to the wiring diagram below. Then select the desired LED colour temperature.

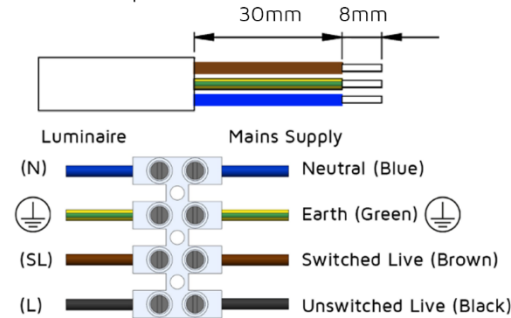

Tri-colour temperature switch:

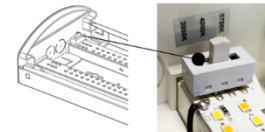

Dual Wattage LED Driver Dip Switch Settings:

**4ft Trinity Surface Linear**

Driver: LC 38W/400-700mA flex C Ip SNC4

ON  ON  
1 2 1 2  
23W/500mA = Switch 1 = On  
Switch 2 = Off

ON  ON  
1 2 1 2  
32W/700mA = Switch 1 = On  
Switch 2 = On

**5ft Trinity Surface Linear**

Driver: LC 57W/70-1050mA flex C Ip SNC4

ON  ON  
1 2 1 2  
34W/700mA = Switch 1 = Off  
Switch 2 = Off

ON  ON  
1 2 1 2  
50W/1050mA = Switch 1 = On  
Switch 2 = On

**6ft Trinity Surface Linear**

Driver: LC 57W/70-1050mA flex C Ip SNC4

ON  ON  
1 2 1 2  
41W/700mA = Switch 1 = Off  
Switch 2 = Off

ON  ON  
1 2 1 2  
60W/1050mA = Switch 1 = On  
Switch 2 = On

**Step 5:** Refit the Diffuser cover by inserting one long edge into the endcap channels, then insert the opposite edge. The Diffuser needs to be pressed inwards to engage the securing channel.

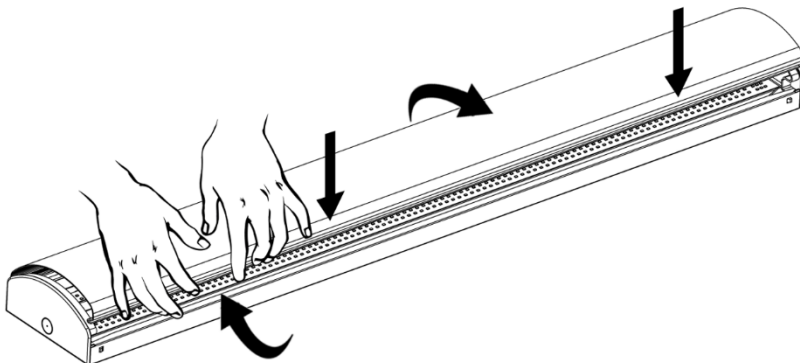

**Step 6:** Dimmable & Dimmable Emergency wiring.



For Dimmable and Dimmable Emergency, please refer to the above QR Code for wiring instructions.

Ensure that the Emergency Test Record is completed.



Part Number:		Installation Date:			
Luminaire Ref/Location		In case of difficulty, contact the Installation Engineers: Tel: _____			
Full Recharge Time 24 Hours		Duration 3 Hours		Lamp Type - LED	
ROUTINE TEST RECORD					
Year 1	Year 2	Year 3	Year 4	Year 5	
Monthly Test	Signed	Date	Signed	Date	Signed
Functional					
Functional					
Functional					
One Hour					
Functional					
Functional					
Functional					
Three Hour					

Example of Emergency Test Report

#### Safety Information:

- The dimming cables should be run separately from the connections and mains cables to ensure good EMC conditions.

#### Wiring the plug-in terminal:

- Use solid wire or stranded wire with the correct cross-section
- Strip off correct length of insulation; you may need to twist the tool slightly
- If stranded wire is used: push onto the terminal from above to be able to insert the wire
- Insert the bare end into the terminal

#### Detaching the plug-in terminal:

- Push onto the terminal from above to release the wire
- Pull out the wire at the front

Mains supply wires  
Stranded with or solid wire from  
0.5 to 2.5mm<sup>2</sup> may be used for  
wiring.

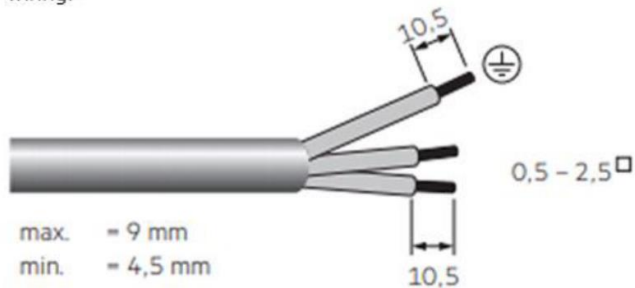

For more information regarding driver settings/options, please access the QR code below:



Tridonic LCA PRE, LC EXC



Certificate No. FS 590684



Certificate No. EMS 590685

# TRIDONIC

Dimming Driver  
Installation Guide

Distributed by  
**NET LED**  
LIGHTING



NET LED Lighting  
Buckingham Business Park  
300 Anderson Road  
Cambridge  
CB24 4UQ  
sales@netled.co.uk  
www.netled.co.uk

Technical Helpline: 01223 851505  
Email: support@netled.co.uk

www.netled.co.uk/downloads  
PRD-40-10-81

**Installation procedure:** Carefully read the installation instructions and ensure the mains supply is isolated before installation. Please follow the safety information overleaf before carrying out any installation. Please retain this leaflet for future reference.

### DALI

#### **Description:**

DALI (Digital Addressable Lighting Interface) is an interface protocol for digital communication between electronic lighting equipment.

#### **DALI offers a lot of possibilities:**

- DALI line: 64 LED Driver can be grouped to a line
- DALI groups: Every LED Driver can be attributed into 16 groups
- Addressability: All LED Driver are individually addressable
- Grouping: Possible without complicated rewiring
- Programmability: Individual programmability makes it possible to use functions which transcend the DALI standard
- Monitoring: Easily possible thanks to status feedback
- Wiring: Simple wiring with five pole standard cables and a cable length of max. 300 metres
- Wiring: Polarity-free control lines can be used for mains and control lines
- Wiring: Multiple wiring possibilities (star, series and mixed wiring)
- Unaffected by interruptions: All luminaires receive the same, unaffected digital signal and dimming level
- Similar light level from first to last luminaire.

#### **Technical data of a DALI line:**

- DALI voltage: 9.5V - 22.4V
- Maximum DALI system current: max. 250mA
- Data transfer rate: 1200 Baud
- Maximum line length: up to 300m (for 1.5mm<sup>2</sup>)

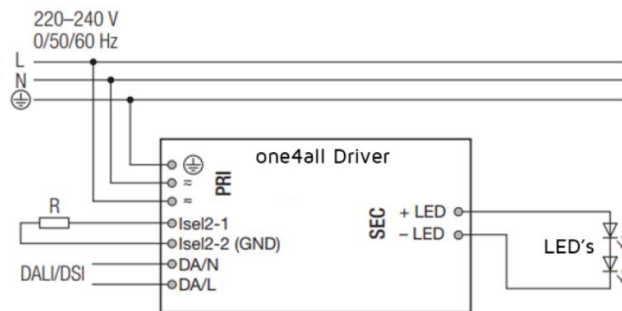

### switchDIM/Push

#### **Description:**

With the switchDIM function it is possible to use the mains voltage as a control signal.

The phase of a standard mains voltage push button is connected to the terminal marked DA/L and the neutral conductor is connected to the terminal marked DA/N.

Using the function is easy and convenient:

- A short press (50-600 ms) switches the device on or off
- A long press (>600 ms) fades the connected operating device alternately up and down (between 1 and 100%)

The device has a switchDIM memory function. This is used, among other things, for storing the last dimming value in the event of interruptions in the power supply.

When power returns, the LED is automatically restored to its previous operating state and dimmed to the last value.

#### **⚠ Caution!**

Glow switches are not approved for controlling switchDIM. Glow switches may cause the LED Driver to spontaneously switch on or off or make sudden changes in the dimming value.

#### **⚠ Caution!**

A maximum number of 25 operating devices per switchDIM system should not be exceeded. If you have more devices please use DALI.

