

Safety Information

>All electrical work must be undertaken by a qualified contractor to ensure compliance with latest edition BS7671 and IEE/IET wiring regulations.

> Before installing the Emergency kit or doing any maintenance, ensure power supply is turned off at the circuit breaker or fuse box.

> This product is designed for permanent connection to fixed wiring; the circuit should be protected with the appropriate MCB or fuse.

Environment

>Please DO NOT dispose of electrical items or packaging as unsorted waste. Use the recycling facilities provided by your local authorities.

PRODUCT DIMENSIONS



Emergency Inverter Dimensions

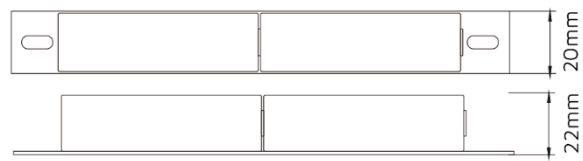

Emergency Battery Dimensions

Important Warranty Information

The Emergency Lighting Kit has a 3 year warranty. To claim you must provide the product part number and date of manufacture, which can be found on the label attached to the luminaire housing along with the original purchase invoice.



Certificate No. FS 590684



Certificate No. EMS 590685

NET LED Lighting
Buckwing Business Park
300 Anderson Road
Cambridge, UK
CB24 4UQ
sales@netled.co.uk
www.netled.co.uk

Technical Helpline: 01223 851505
Email: support@netled.co.uk

www.netled.co.uk/downloads

Distributed by



Manual/Self Test Selectable LED Converter for LED Tubes

NET-50-12-10



POWER SUPPLY

Driver
220-240V AC 50/60 Hz
Fig.1 Mains Input Termination

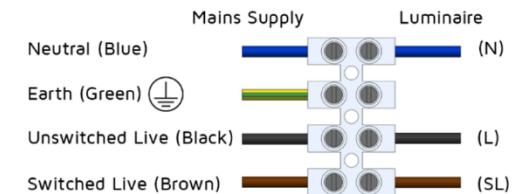

Installation procedure: Carefully read the installation instructions and ensure the mains supply is isolated before installation. Please follow the safety information overleaf before carrying out any installation. Please retain this leaflet for future reference.

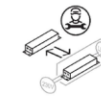

Replaceable control gear by a professional

Step 1: Wiring Connection Details

Remove the Emergency Kit from the packaging. Connect the Emergency kit to the LED Tube following the wiring guide which shows the typical wiring of the Emergency kit. The Emergency kit must have a connection to an Unswitched supply originating from the same supply as the mains lighting in the area in which it is to be installed. When wiring is complete, ensure the cables are secured in place using the fixings supplied.

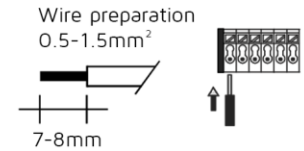
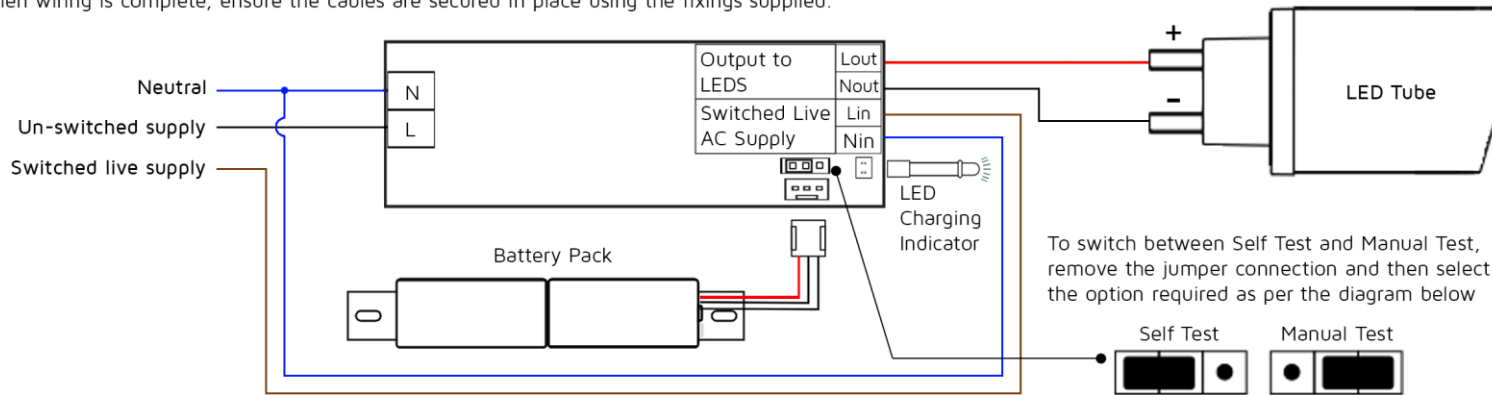

Technical Specifications	
Power	2.5W Max
Input Voltage AC	220-240V
Power Factor	0.5
Output Current	DC 50-300V
Output Power	2.5W
Battery Pack	LiFePO4 3.2V 3.2mAh
U-out	40mA max
Recharge Period	≥24Hours
Hours Maintained	>3Hours
Operating Temperature	0°C to 60°C

Step 2: Apply Mains Supply

Apply mains supply to test the LED tube. The indicator LED will show green.

NOTE: The indicator LED must be visible when the fitting is in normal use, in accordance with BS EN 60598-2-22.

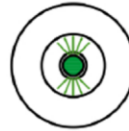

Step 3: Test Emergency Supply

To test, briefly fail the unswitched and mains supply to illuminate fitting using the internal battery. The LED indicator will be extinguished and the LEDs on the Tube will illuminate.

NOTE: If the battery has not been charged for an extended period, the luminaire may only illuminate briefly or fail to operate until the battery is charged.

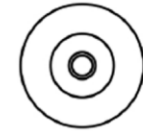

General Description

- Luminaire should only be installed by suitably qualified personnel.
- Installation should be carried out in accordance with the requirements of BS7671 and luminaires located as required by BS5266 Pt. 1 as well as BS EN 1838 and BS EN 50172.
- Before installing, connecting or servicing these luminaires, isolate the mains supply to which they are to be connected.
- To comply with the requirements of BS EN 50172, it is necessary to record the indicator LED status.

Self-test:

The emergency kits carry out self-tests automatically to ensure its functionality. The self-test includes 3 types of tests:

Initial test:

- As soon as mains supply is connected, the emergency kit will carry out a 3 second functional test automatically.
- In case of failure, the LED will turn permanent red. Otherwise, the charge mode will start.

Functional test:

- Refers to charging, discharging and the functioning load.
- Carry out 10 seconds automatically every 30 calendar days.

Duration Test:

- Refers to the test of batteries capacity.
- Carry out every 180 calendar days.

Explanation of LED indicator

	Colour	LED indicator	Status	Comment
	Green	Slow flashing green (3 sec on, 1 sec off)	Charging mode	AC mode
	Green	Permanent green	Fully charged	AC mode
	Green	Fast flashing green (0.1 sec on, 1 sec off)	Function test underway	
	Green	Slow flashing green (1 sec on, 1 sec off)	Duration test underway	
	Red	Permanent red	Load failure	Open circuit / Short circuit LED failure (emergency mode)
	Red	Slow flashing red (1 sec on, 1 sec off)	Battery failure	Battery failed the duration test or function test / No battery
		Green and red off	DC mode	Battery operation (emergency mode)

